



3 & 4 Way Multi-Port Ball Valves

MULTI-PORT SERIES

Model:

MPT100 3-Way

MPT104 4-Way



Size: 1/4" - 2"

MPT100 / MPT104 Series

STANDARD PRODUCT NUMBER

MPT100-SS-L-FFF-L (MPT100 L-Port)

MPT100-SS-T-FFF-L (MPT100 T-Port)

MPT104-SS-L-FFF-L (MPT100 L-Port)

MPT104-SS-T-FFF-L (MPT104 T-Port)

MPT104-SS-LL-FFF-L (MPT104 LL-Port)

UNIQUE DESIGN FEATURES:

- Size Range: 1/4" - 2"
- Pressure Rating: 800 MAWP/WOG
- Temperature Range: Consult Factory
- Locking Handle, Locks At 90° Intervals, Full 360° (for MPT100 only)
- Quality Investment Cast Components
- All Stainless Steel Construction
- Optional Anti-Static Grounding Device
- Threaded Ends
- Optional Tri-Clamp And Flanged Ends
- I-SO Actuator Mounting
- Locking Handle Standard On All Valves
- All Valve Solutions Annealed
- All Valves have four seats which allows operation in the Off Position.

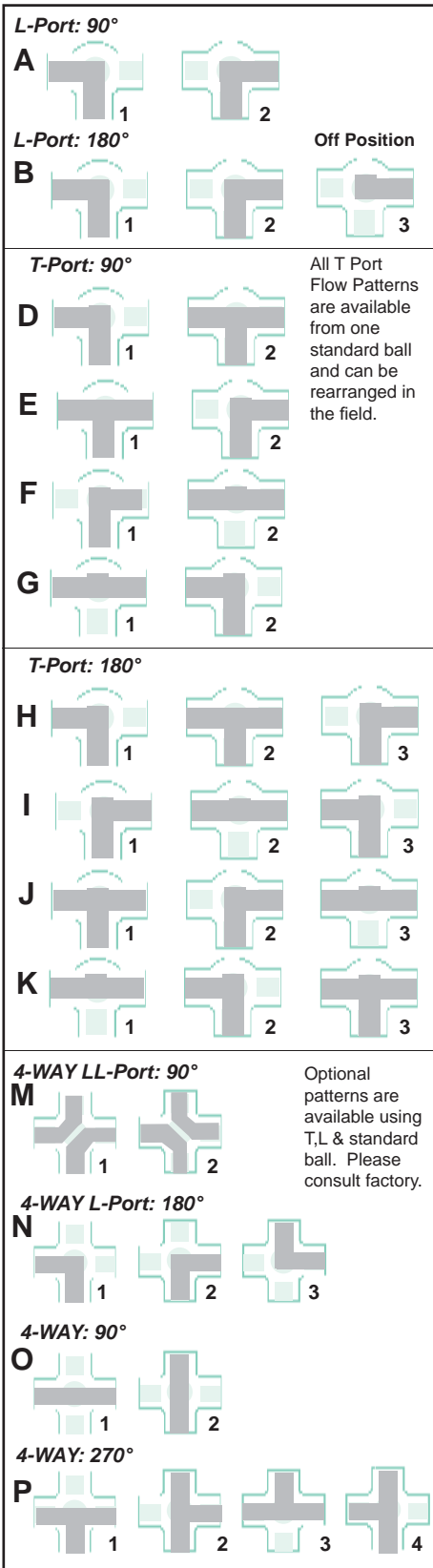

3 WAY VALVES

REDUCE THE NUMBER OF VALVES IN PIPING SYSTEMS AND INCREASE EFFICIENCY.

3 WAY STANDARD PORT BALL VALVE 800 WOG

BILL OF MATERIALS:

PART NAME	QTY	MATERIAL
1 BODY	1	A351 CF8M / SS316
2 END CAPS	3	A315 CF8M / SS316
3 BALL	1	A351 CF8M / SS316
4 SEATS	#	SUPER TEK TFM
5 STEM	1	SS316
6 PACKING	#	PTFE
7 GLAND NUT	1	SS304
8 WASHERS	2	SS304
9 STEM CAP NUT	1	SS304
10 HANDLE	1	SS304
11 PLASTIC COVER	1	VINYL PLASTIC
12 THRUST WASHER #	1	PTFE
13 FLAT WASHER	1	SS304
14 STOP PIN	1	SS304

Parts included in repair kits

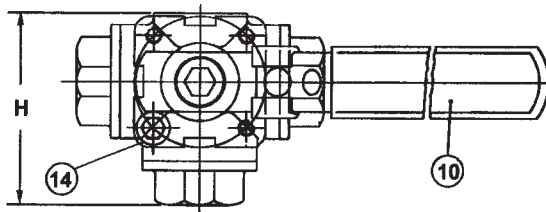

Note:

- ⊗ Now available 3 Way Valve With Clamp Type Sanitary Ends - Model MPC100
- ⊗ ANSI Class 150 And 300 LB, MPF15 and MPF30

MOUNTING DIMENSIONS

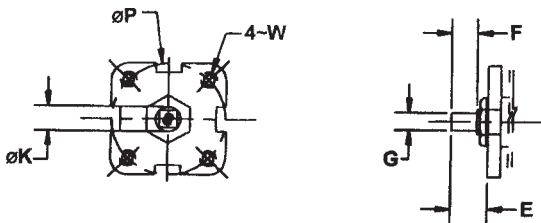

Valve Components

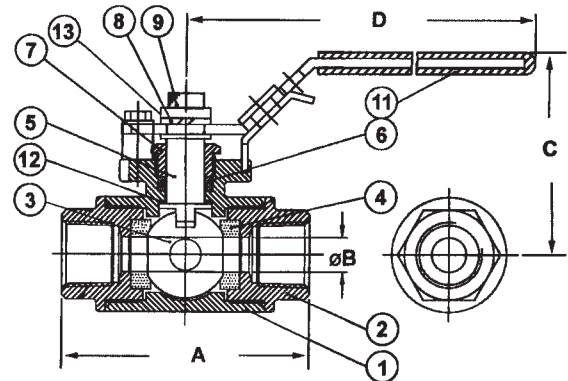

SPECIFICATIONS:

Body Test Pressure: 1200 PSIG Hydrostatic
 Pressure Rating: 800 WOG
 Threaded End Connections Meet ANSI B1.20.1

- Our Unique new handle design has position stops in 90° increments for full 360° operation (for MPT100 only).
- A wide variety of special seat materials are available C/F.
- Valves Stem Seals and Seats 100% tested by 100 psig air under water for bubble tight integrity.

Pressure Temperature Rating

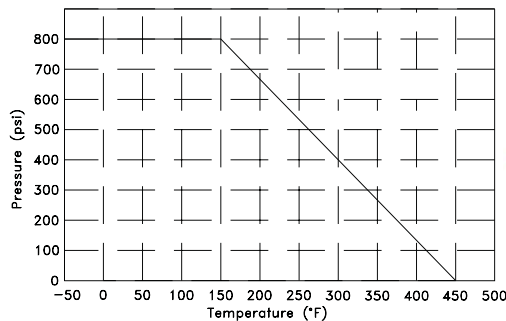

ATTENTION
 MAWP/WOG is a do not exceed pressure at normal ambient NPT & Weld End Models

DIMENSIONS AND WEIGHTS:

VALVE SIZE	1/4"	3/8"	1/2"	3/4"	1"	1 1/4"	1 1/2"	2"
A	3.11	3.11	3.11	3.35	4.25	4.88	5.31	6.46
B	0.43	0.43	0.43	0.59	0.79	0.98	1.26	1.57
C	2.54	2.54	2.54	3.05	3.19	3.46	3.66	4.13
D	6.50	6.50	6.50	7.87	7.87	9.06	9.84	10.43
E	0.43	0.43	0.43	0.51	0.75	0.93	0.93	0.96
F	0.20	0.20	0.20	0.28	0.45	0.61	0.61	0.63
G	0.35	0.35	0.35	0.43	0.43	0.43	0.43	0.55
H	2.42	2.42	2.42	2.83	3.35	3.78	4.23	5.12
K	0.47	0.47	0.47	0.59	0.59	0.59	0.59	0.73
P	1.65	1.65	1.65	1.97	1.97	1.97	2.76	2.76
W	10-24UNC	10-24UNC	10-24UNC	1/4-20UNC	1/4-20UNC	1/4-20UNC	5/16-18UNC	5/16-18UNC
CV - 90°	3.2	3.5	4.5	10	16	31	49	82
CV - 180°	3.6	4.8	7.0	14	27	43	72	113
Valve Torque (in-lbs)	70	80	90	170	260	390	550	800
App. Weight (lbs)	1.80	1.80	1.80	2.73	3.79	4.74	9.00	15.5



Flo-Tite, Inc.
 4815 West 5th St.
 Lumberton, NC 28358

P. O. Box 1293
 Lumberton, NC 28359
 Website: www.flotite.com

Tel: (910) 738-8904
 Fax: (910) 738-9112
 E-mail: flotite@flotite.com

Due to continuous development & improvement of our product range, we reserve the right to alter the dimensions and technical data included in this brochure.